

“COLORAM II is the nucleus of an ever-expanding line of lighting accessories.”

And no other color changer is backed by a twenty-year record. THE COLORAM II is the latest and most advanced scroller from the company that invented them - and it shows. THE COLORAM II works better and lasts longer, proving that there really is no substitute for experience.

THE COLORAM II is also just one piece

in the ever-expanding **COLORAM SYSTEM OF INTEGRATED LIGHTING ACCESSORIES** - a system which includes CXI Color Fusion color changer, GOBORAM Gobo Changers and ECLIPSE Dowzers for additional effects, and THE WATCHDOG Diagnostic System to keep everything in check.

**PEERLESS INNOVATION, PRECISION ENGINEERING**

Every COLORAM II is precision engineered to provide you precision

operation. It is a fully digital color changer, meaning your commands create exact gel frame positioning every time, with no analog pot adjustments. And the system auto-calibrates each time you power up, counting the frames of color, and accounting for any changes in roll diameter due to normal gel wear.

COLORAM II is the only color changer with built-in Intelligent Diagnostics, allowing you to monitor your rig for overall Coloram system configuration and the current health and status of each COLORAM head unit and power supply. You get real-time information on gelstring position, voltage levels, fan and motor operations, and immediate alerts on disconnects, shutdowns or other errors.



**THE STANDARD IN SCROLLING COLOR CHANGERS**

For two decades, one name has risen above all others when it comes to scrolling color changers: Wybron.

Today is no exception. THE COLORAM II is the standard in professional color changing, offering the widest array of features, the greatest utility and unparalleled reliability. With more colors, the quietest, most precise gel movement, and models for nearly every fixture made, no other scroller even comes close.





“Exact gel-frame positioning every single time”

THE COLORAM II also offers more colors - up to 32 frames per color changer, expanding your color options for each number or scene in the show. Unlike with color mixing systems, THE COLORAM II gives you exactly the colors you want - not the closest available approximation - with negligible light loss.

COLORAM Power Supplies come in three models - 6-Way, 12-Way and 24-Way - giving you the flexibility and cost-efficiency you need to build your rig.

#### **AQUARAM: WHEN THE SHOW MUST GO ON**

There's one other color changer in THE COLORAM II family for everyone who's ever set up a show with one worried eye on the gathering clouds: THE AQUARAM.

THE AQUARAM has all the features and reliability of COLORAM II, with the added ability to withstand Mother Nature's outbursts. It comes in two sizes: 7.5 Inch and Large Format, each with standard features that give you peace of mind and perfect performance wherever rain or water spray is possible.

Every component of THE AQUARAM is built to withstand the elements. The control switch panels are water resistant, the vents shrouded, and the internal connections plated with gold. The circuit board is conformal coated, protecting the electronics, and rubber seals secure the transparent panels over THE AQUARAM's front and rear apertures.

The hatches may be battened down, but the front panel still opens like a breeze for easy gelstring installation. We thought of everything, so you can think about your show - not the weather.

“Weather-protected performance and COLORAM reliability”

readout on your COLORAM Power Supplies or, better yet, right at your PC using THE WATCHDOG Monitoring System.

Three-setting fan control is another innovative feature unique to THE COLORAM II. Choose low speed for whisper-quiet operation; normal speed for extended gelstring life; or off when a particular fixture is not in use. You control the settings right from your lighting console using a special DMX channel.

#### **MORE SIZES, MORE COLORS, MORE POWER**

In entertainment lighting, size matters, and THE COLORAM II comes in more sizes than any other color changer - six in all. If it's in your rig, chances are we make a COLORAM II to fit it.



# GENERAL SPECIFICATIONS - THE COLORAM COLOR CHANGER

## DIMENSIONS-COLORAM HEADS

### 4-INCH MODEL

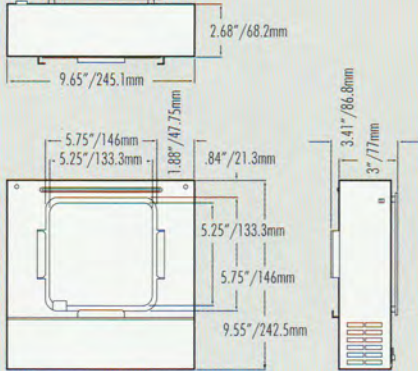

**Weight:** 3.66 lbs./1.66 kg without mounting plate and gelstring

### 7.5-INCH MODEL

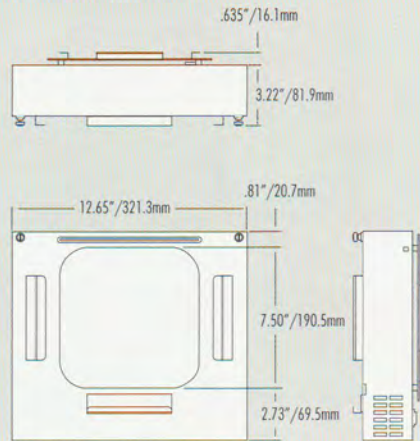

**Weight:** 4.2 lbs./1.9 kg without mounting plate and gelstring

### 10-INCH MODEL

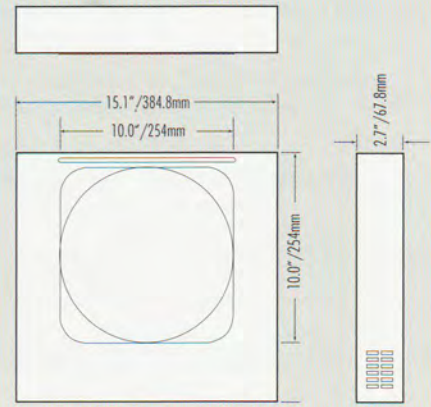

**Weight:** 4.96 lbs./2.24 kg without mounting plate and gelstring

### 5K MODEL

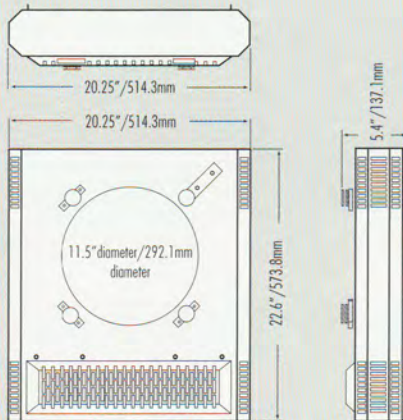

**Weight:** 11.86 lbs./5.37 kg without mounting plate and gelstring

### LARGE FORMAT MODEL

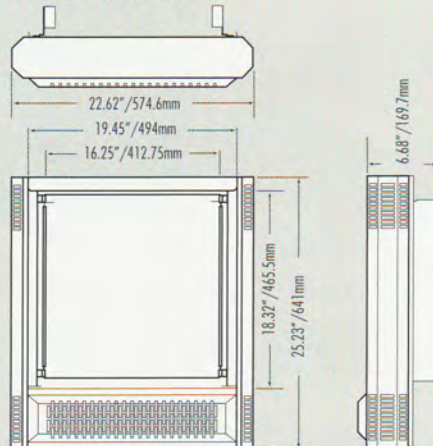

**Weight:** 12.00 lbs./5.44 kg without mounting plate and gelstring

### EIGHT LIGHT MODEL

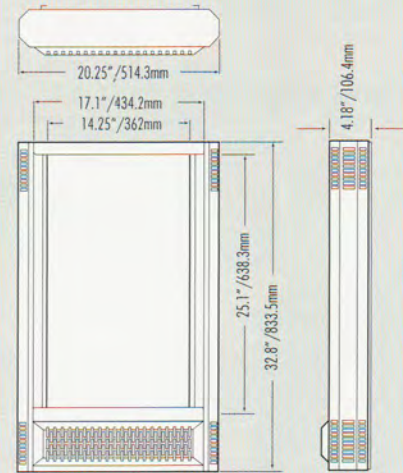

**Weight:** 14.24 lbs./6.45 kg without mounting plate and gelstring

### AQUARAM MODEL

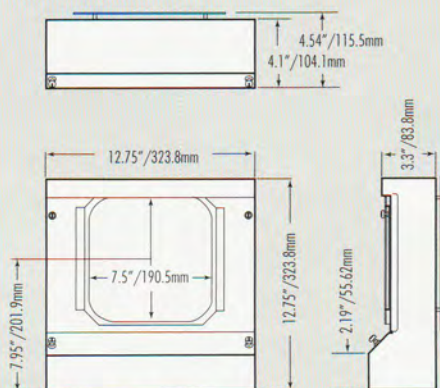

**Weight:** 7.08 lbs./3.21 kg without mounting plate and gelstring

### AQUARAM LARGE FORMAT MODEL

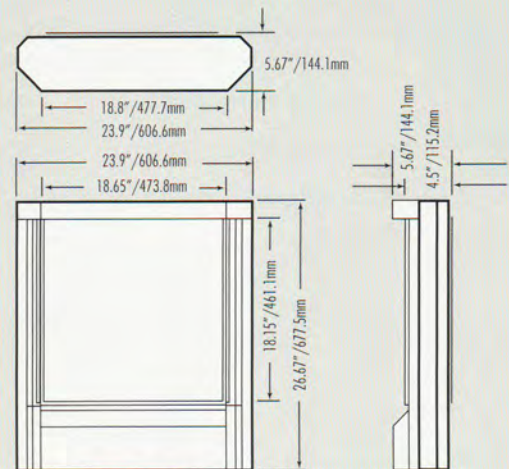

**Weight:** 22.0 lbs./9.98 kg without mounting plate and gelstring

\*Units not to relative scale

## GENERAL SPECIFICATIONS - THE COLORAM COLOR CHANGER

### FEATURES-COLORAM HEADS

<b>Motor</b>	Quick, quiet direct drive, no gear box
<b>Gelstring Format</b>	2-32 colors (2-24 colors for 10-in. and larger models)
<b>Gel movement</b>	Continuous, no indexing
<b>Two-speed Fan</b>	Normal speed for extended gel life, low for silent operation, and off; controllable from console thru DMX channel
<b>Speed</b>	Varies per model; 7.5-in. Model end to end in 2.5 seconds
<b>Head Unit Intelligent Diagnostics</b>	On/off line, gel position, DC voltage at the head, shutdown and more at the head, shutdown and more (note: this info available at power supply)
<b>LED Status Panel</b>	Provides indication of operating modes from a distance

<b>Top Hat Mount</b>	Built in for use of top hats and accessories for the 4-in., 7.5-in., and 5K Models (available as accessory for 10-in. Model)
<b>Mounting Plates</b>	Various to fit a wide variety of fixtures
<b>Safety Cable</b>	3.5-ft./1.06m long cable included
<b>Low Voltage Indicators</b>	Two stage-warnings of cables too long or bad connections Stage 1-warning light on status panel Stage 2-shut down to prevent running off rollers
<b>Gelstring Operating Modes</b>	1. Top speed normal - good top speed, smooth cross fades, quiet operation 2. Top speed limited - smooth, quiet operation at slow speed, does not require timed cross fades for changes
<b>Daisy Chaining</b>	Individual ID's on one home run

### TECHNICAL DATA-COLORAM HEADS

#### Current Requirements (@ 24 VDC)

7.5-in. & 4-in. Model	.28A average
5" Model & Larger	.57A average

**Input Control Signal** From Coloram power supply

**Fuse Value** 1.5 amps slo blo  
(2 amps Large Format)

### BASIC SETUP - COLORAM HEADS

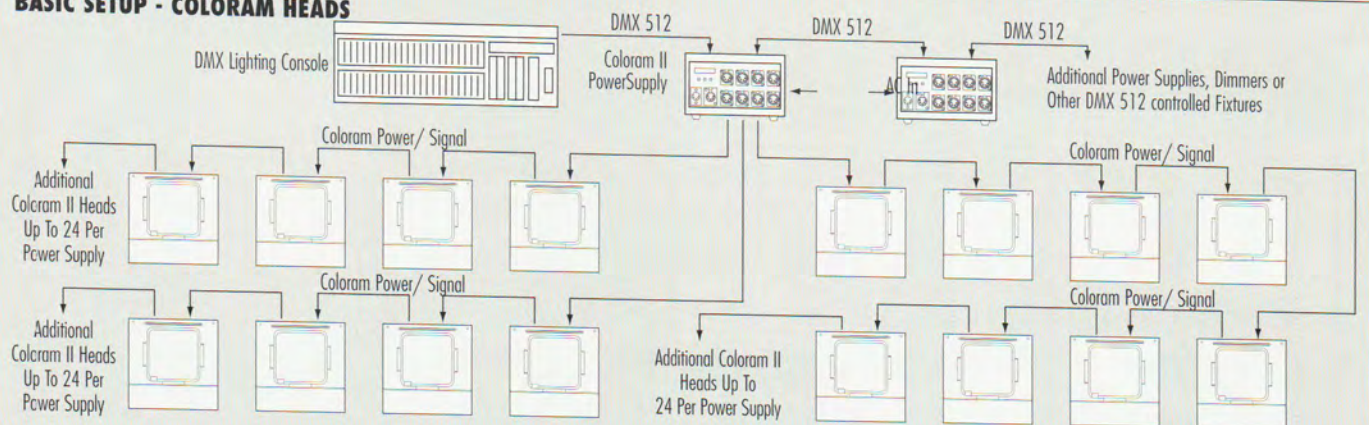

**NOTE:** Please refer to the cable length calculation section of the Coloram II Manual when determining the number of heads per Power Supply output connector.